

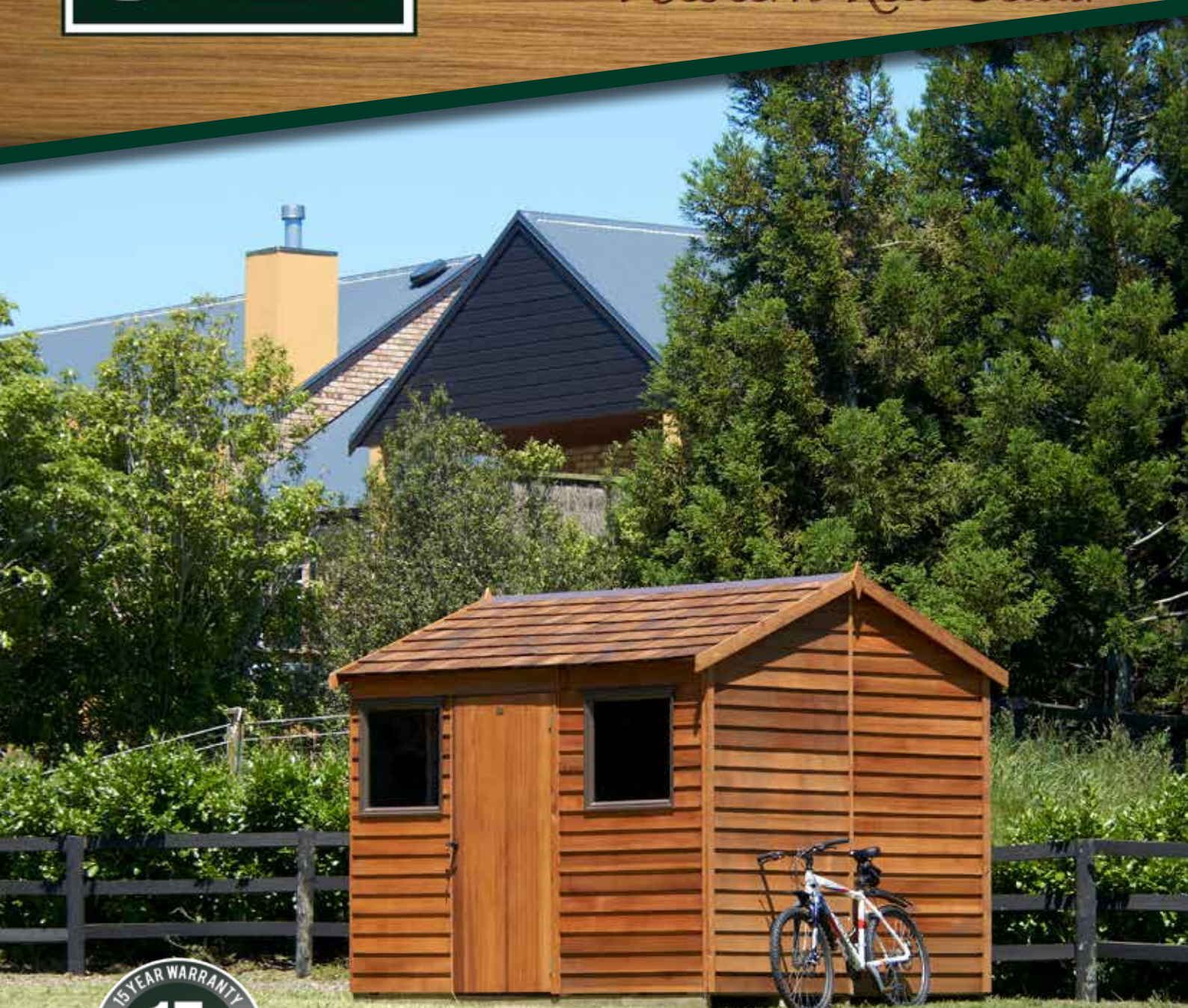

*The luxurious,
rich look of genuine
Western Red Cedar*



**NEW ZEALAND
MADE**



thecedarshed.co.nz

Introducing The Ultimate In Luxurious Storage...

Known as the ultimate Timber storage building, The Cedar Shed has been manufactured in New Zealand since 1987. The Cedar range of sheds offers beautiful looks along with outstanding quality that needless to say, is built into the Cedar clad design.

Nestled amongst the trees or placed as a show piece, cedar sheds make a statement and provide a natural look that goes hand in hand with our beautiful country. A Cedar shed retains a distinguished appearance that lends a mark of quality to any home, and is an investment you won't regret.

WESTERN RED CEDAR..... WHY YOU'LL LOVE IT.

As one of the worlds most durable timbers, Cedar lasts for decades and even centuries in the harshest of environments. Light in weight, uniformly textured, straight-grained and containing no resin, Western Red Cedar is easy to work with, making it the ultimate choice in timber shed construction.

It's Beautiful - No man-made material can duplicate the depth of Western Red Cedar's natural lustre. Western Red Cedar's rich grain and vibrant colour make it the best material for all applications where beauty is important. Of all woods, Cedar ranks at the top in it's ability to accept and maintain an attractive finish.

It's Strong - Western Red Cedar has excellent dimensional stability and endurance. This is an important characteristic for timber cladding as it lays flat and stays straight. The even grain and relatively consistent density make Western Red Cedar less likely to swell, warp, cup and twist than other more readily available timbers.

Long-Lasting - Cedar fibres contain natural oils called thujaplicins that act as natural preservatives, making the wood extremely long-lasting and assisting the wood to resist insect attack and decay. Properly finished and maintained, Western

Red Cedar ages gracefully and endures for many years. Many people use our specially formulated Endurance Cedar Protectant to enhance the natural fibres and bring out the rich colours that lie within, while extending the life of their shed.

Non-Toxic - Western Red Cedar is non-toxic and requires no chemical treatment when used on the cladding of our Cedar sheds. Because it is rich in extractives that enhance durability, Cedar does not require harmful chemical treatments and is free of the pitch and resin found in other timbers, along with other additives such as arsenic. A safe option in your backyard!

Smells Great - Western Red Cedar is well known for its distinctive aroma. Over the course of time the wood retains its subtle aroma and the characteristic fragrance adds another dimension to the overall appeal of the Cedar storage sheds. This is one of little things that will impress you every time you are in or around your Cedar Shed.

SUPERIOR CONSTRUCTION.....MAKING IT LAST

Modular Assembly System - This system has been distinctive to Cedar sheds for over 30 years and is constructed from 45x45mm pre treated framing, clad with premium Canadian sourced Cedar weatherboards.

Building Paper - Each panel is lined with heavy duty building paper creating an ultra dry interior. Great for storing important documents and items that don't like moisture.

Stainless Steel Staples - These are used to fasten the Cedar weatherboards to the timber frame creating a structure that will last. Great for coastal areas and other harsh environments.

Robust Optional Floor - This is an option with any Cedar Shed purchased. The floor kit is precut in the factory and includes H4 treated joists and sturdy pine floor boards.

Features and Benefits



Rustic or Contemporary
Your choice of shingle or pre-painted steel roof.

High Quality Joinery
Residential grade fixed or opening aluminium windows optional on all models.

Modular Panel Design
Pre-made panels make for quick and easy installation.

No Condensation
Fully lined with building paper. Keeps your gear moisture free.

Solid Treated Timber Frame
Makes easy fixing of shelves, workbenches and lining kits.

Lockable Resin Handle
No rusty pad-bolts or missing padlocks.

Solid Tongue & Groove Cedar Door

Waterproof!
PVC weather-strip provides a water tight floor.

Anti Rust Stainless Fixings
Long-lasting. Perfect for coastal locations.

“ It looks fantastic! And worth every cent. I will recommend it to anyone wanting that 'Touch of Class' in their back yard. Well done! ”
A. Roest

STEEL ROOF & WINDOW COLOUR OPTIONS

Choose from these 4 popular colour options.

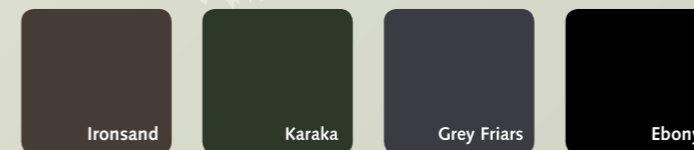

* Your new shed is guaranteed against defective material and faulty workmanship for fifteen years from date of purchase.

* Terms and conditions apply. Full warranty details are sent with your shed or can be requested from the distributor.



EASY INSTALLATION WITH THE MODULAR ASSEMBLY SYSTEM



KITSET ARRIVES



LAY OUT PRE-MADE PANELS



ASSEMBLE PRE-CUT FLOOR



STAND UP WALL PANELS



FIT ROOF



FIT DOOR



ATTACH FASCIA



FILL IT UP!

Cambridge Locker

Base Dimension	1.800 x 0.840 x 1.825m
Roof Size - Colour roof	1.840 x 0.895m
Door	1110mm opening

The Cambridge Locker is a small garden shed with a difference – its compact, makes it easy to access your gear and adds a touch of class to your backyard! The pre-painted Ironsand steel skillion roof and back wall construction allows the shed to be positioned against your house or fence, saving you valuable space. Includes floor and 3 shelves.

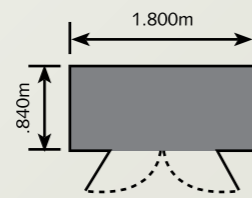
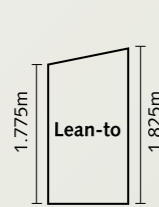

Includes floor & 3 shelves!



Woodbridge

Base Dimension	2.400 x 1.200 x 2.260m
Roof Size - Shingle	2.550 x 1.330m
- Colour roof	2.590 x 1.330m
Door	840mm opening
Concrete Slab	2.385 x 1.175m

A longer version of the popular Hampshire. The Woodridge provides excellent usable storage space against the house.



Shown with optional pre-painted steel roof.

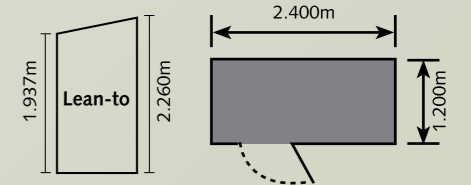

Hampshire

Base Dimension	1.800 x 1.200 x 2.260m
Roof Size - Shingle	1.950 x 1.330m
- Colour roof	2.095 x 1.330m
Door	840mm opening
Concrete Slab	1.785 x 1.175m

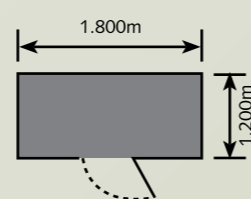
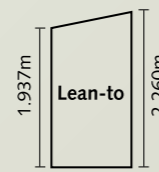

This skillion model provides great storage for properties where space is at a premium. Against the house or fence is an ideal spot for this shed with a lean-to roof that directs the water away from the rear.



Ferndale

Base Dimension	1.800 x 1.890 x 2.365m
Roof Size - Shingle	1.950 x 2.160m
- Colour roof	2.095 x 2.160m
Door	840mm opening
Concrete Slab	1.875 x 1.795m

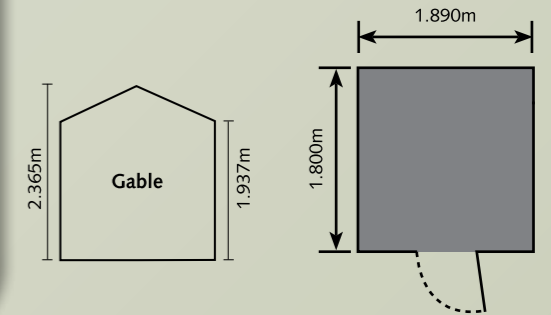

The Ferndale is a square shaped shed that provides ample storage for smaller garden items.

The door in the gable end gives a unique look. Like all Cedar sheds, a window can be added as an optional extra if desired.

A great little shed and a complement to any backyard.



Sherwood

Base Dimension	1.890 x 2.400 x 2.365m
Roof Size - Shingle	2.160 x 2.550m
- Colour roof	2.160 x 2.595m
Door	840mm opening
Concrete Slab	1.875 x 2.385m

The Sherwood is shown here featuring the Grey Friars optional colour steel roof.

Like the Ferndale, the Sherwood offers end access which is user friendly for the storage of bikes and other longer items.

This style will often fit snugly between a house and the fence making excellent use of space.

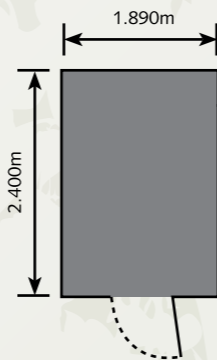

Also available with Shingle roof.



Millbrook

Base Dimension	2.400 x 1.890 x 2.365m
Roof Size - Shingle	2.550 x 2.160m
- Colour roof	2.595 x 2.160m
Door	840mm opening
Concrete Slab	2.385 x 1.875m

The dimensions and conventional shape of the Millbrook places it in the "most popular size garden shed" category.

The Millbrook is a great all rounder. All your traditional garden gear will fit in here with ease.

Please note....chooks and other props are not included!

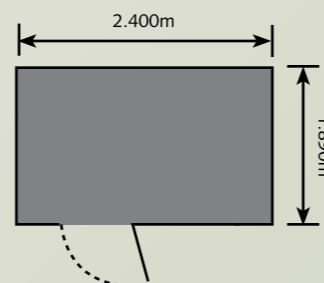

Shown with optional Lignite aluminium window.

Astor

Base Dimension	2.400 x 1.890 x 2.365m
Roof Size - Shingle	2.550 x 2.160m
- Colour roof	2.595 x 2.160m
Door	1.710m opening
Concrete Slab	2.385 x 1.875m

This beauty is perfect for a bike shed. The same size as the 'Millbrook', but with double doors in the side making easy access for bikes and bigger items.

Lots of kids toys? Need a pool shed? Get an Astor!



Shown with pre-painted Karaka steel roof option.

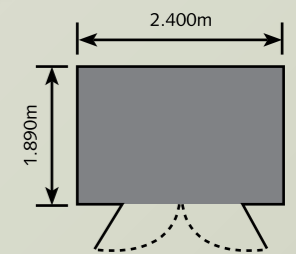

Shown with optional fixed Lignite aluminium window.



Shown with pre-painted Ebony steel roof & Window frame option.

Logan

Base Dimension	2.700 x 1.890 x 2.365m
Roof Size - Shingle	2.850 x 2.160m
- Colour roof	2.930 x 2.160m
Door	840mm opening
Concrete Slab	2.685 x 1.875m

The 'Logan' is another top seller and with the door in the centre of the long side, there is liberal work and storage space inside and room for a workbench too.

As pictured, the Logan featuring a fixed aluminum window as an optional extra. Popular and practical best describes the Logan.

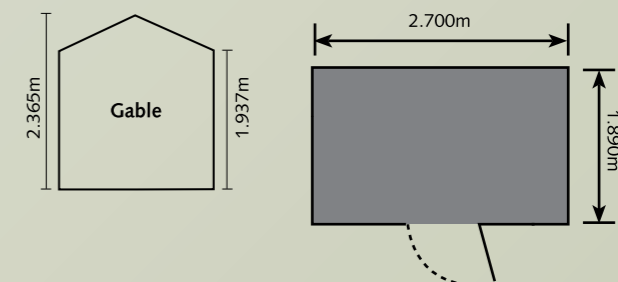



Shown with optional fixed aluminium window & Ironsand steel roof option.

Regent

Base Dimension	3.600 x 1.890 x 2.365m
Roof Size - Shingle	3.750 x 2.160m
- Colour roof	3.765 x 2.160m
Door	840mm opening
Concrete Slab	3.585 x 1.875m

The all new longer version of our top selling Logan the "Regent" has liberal work and storage space inside and ample room for a workbench too.

Double doors are available as an option should you wish to store your dirt bikes, bigger items or want better accessibility.

Optional window as shown provides plenty of natural light to work in.



Shown with shingle roof option.

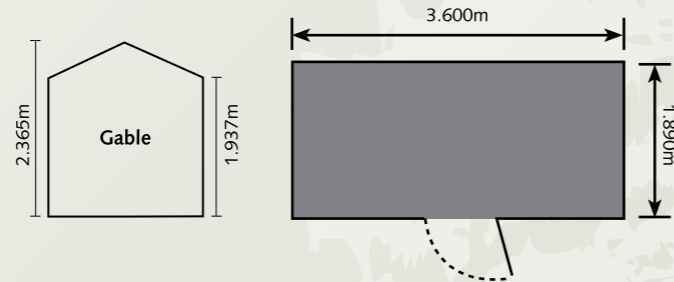

Shown with optional Lignite aluminium window.

Montrose

Base Dimension	3.000 x 2.490 x 2.495m
Roof Size - Shingle	3.150 x 2.735m
- Colour roof	3.265 x 2.735m
Door	840mm opening
Concrete Slab	2.985 x 2.475m

With a spacious 2.5m of depth, the Montrose can be used as a full sized workshop, or has enough room to almost completely clear out your garage. It can also be supplied with double doors.

You can have the optional extra fixed or opening windows as shown. You choose the position of the windows to suit.

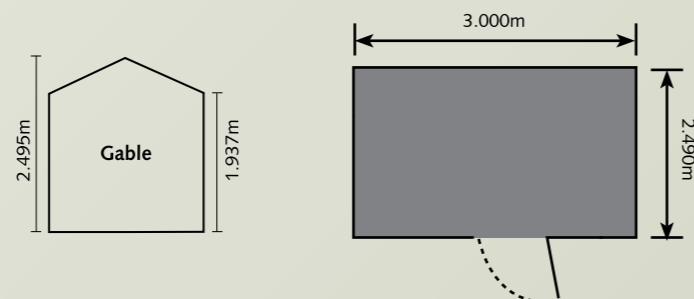

Shown with optional Lignite aluminium window.

Bentley

Base Dimension	3.600 x 2.490 x 2.495m
Roof Size - Shingle	3.750 x 2.735m
- Colour roof	3.765 x 2.735m
Door	840mm opening
Concrete Slab	3.585 x 2.475m

This is the flagship model of the cedar shed range.

The Bentley is big enough to use as an office, studio or hobby room, yet still leaves enough space for a workbench and some storage as well.

Double doors are available as an option should you wish to store your ride-on mower or want better accessibility.

The Bentley ensures you won't be short on storage space. Optional window as shown provide plenty of natural light to work in.

7 hours and all erected, just me and my 9 year old son. The kitset would be the best I have ever worked with so very well done to whomever designed it. It was a pleasure to put up, an excellent product.

Doug

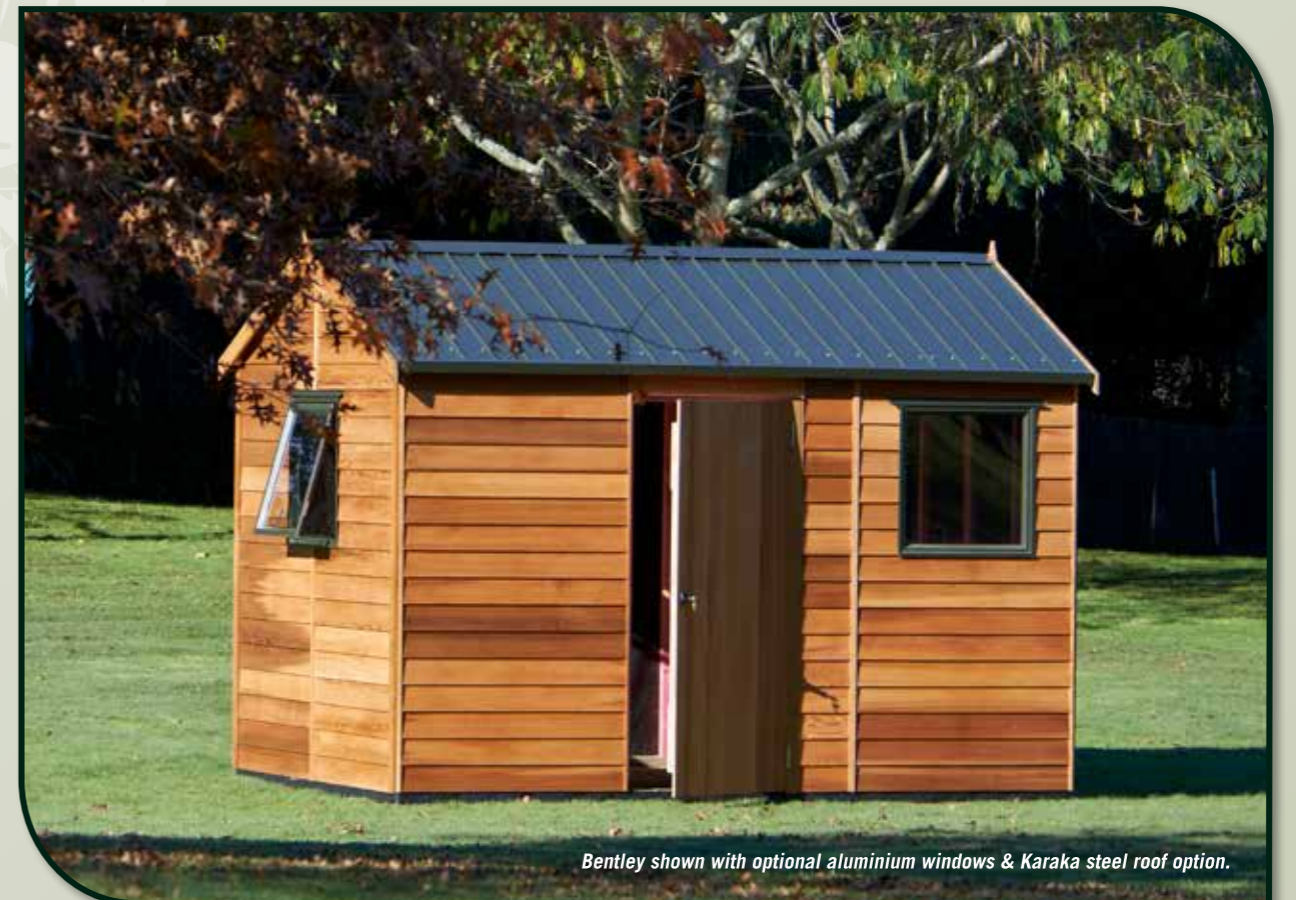
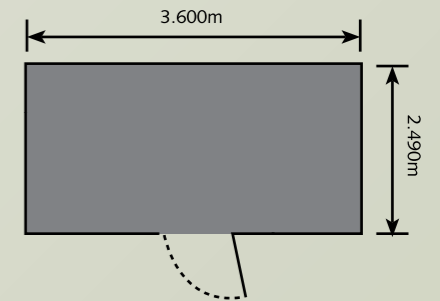

Bentley shown with optional aluminium windows & Karaka steel roof option.



Urban

Base Dimension	3.600 x 2.775 x 2.550m
Roof Size - Colour roof	3.765 x 3.110m
Door	810mm opening
Concrete Slab	3.585 x 2.760m

- Home office
- Studio
- Sleep-out
- Extra room
- Site Shed
- Bach

Working from home and need an office? Or maybe an extra bedroom? The Urban Cedar Shed is the perfect solution for you.

The urban has an added advantage of a 1800mm wide ranch slider, making it light and airy.

As with all the Cedar shed range, the walls and roof come complete with building paper making it dry and also easy to fit a lining kit.

Please note: The shingle roof option is not available in the Urban.

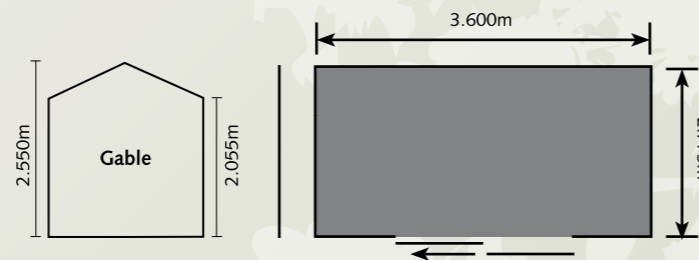

OPTIONAL FLOOR KIT
A sturdy floor option is available with the Urban. The floor kit consists of 17mm H3 plywood on 100 x 50 H4 joists.



OPTIONAL VERANDAH & DECK KIT
Enhance the appeal and practicality of your Urban Cabin with the Verandah and Deck Kit. It looks great and protects you from the elements.

This kit can be purchased as the deck only, or the deck and verandah combination.



REAR VIEW
Optional opening window shown for extra light and improved air flow.

Note: The Cedar Sheds shown in this brochure have been coated with Endurance Cedar Protectant to enhance and preserve their natural beauty. Endurance Cedar Protectant is an optional accessory.

CUSTOMISE YOUR SHED

ROOF OPTIONS



The Cedar Shed range is unique for its ability to adapt to 2 different roof styles.

Choose your roof from the rustic looking popular Cedar shingles, or enjoy the contemporary looking colour roof option.

Colour options available:
Ironsand, Karaka, Grey Friars & Ebony



TIMBER FLOOR OPTION

The optional timber floor kit is a great solution for the base of your Cedar Shed.

Timber floors are both economical, easy to build and mean your shed will be easily relocatable.



SHELF UNIT

Plywood shelf unit with brackets. 300mm wide.

Available in the following lengths: 1200mm, 1800mm and 2400mm



WORKBENCH

Plywood workbench 1800mm x 600mm with sturdy timber framing.



PEG DOWN KIT

Anchor your Cedar shed down securely in sand or dirt substrates.

- 6 x H5 Treated Timber Pegs
- 6 x Stainless Steel Screws



FIXED OR OPENING WINDOW

Add light and ventilation with fixed or opening Aluminium windows. Optional with any Cedar Shed. Windows added to the shingle roof option will be supplied in Lignite colour, while windows added to the steel roof option will be colour matched to the steel roof colour chosen.



DOUBLE DOOR OPTION

Available as an option on models over 2.4 metres in width/length.



ENDURANCE WALL & ROOF PROTECTANT

The Endurance Wall and Shingle Protector enhances and prolongs the great look and life of your Cedar Shed.



BOLT DOWN KIT

Mount your Cedar shed securely to a concrete base.

- 6 x Unique Galvanised Hold-Down Brackets
- 6 x Dynabolts and Screws

MAKE YOUR CHOICE FROM THESE 4 POPULAR STEEL ROOF COLOUR OPTIONS



Note: All windows added to a Cedar shed will be colour-matched to the roof colour option chosen.



For special sizes or colour options not covered in our standard range, please contact us on 0800 438 274 or email sales@riverleagroup.co.nz

thecedarshed.co.nz





CUSTOMER SUPPORT - 0800 438 274

Manufactured by Riverlea Group Ltd
P. O. Box 11062, 2A Maui Street, Hamilton 3200
Ph +64 7 847 0204 Fax +64 7 847 0205
customer care@riverleagroup.co.nz / thecedarshed.co.nz

